

# Panasonic

## AG-CX350

Memory Card Camera Recorder

High-End 1.0-type Handheld Camcorder with 4K/HDR/10-bit Capabilities.  
Supports IP Control, NDI | HX and RTMP Streaming.

CREATIVITY × CONNECTIVITY



**AVC ULTRA HDR**



A NEW CX SERIES 4K CAMCORDER DELIVER NEXT-



# CREATIVITY

4K/HDR 10-BIT REC

4K (UHD)/10-bit/60p High-Quality Image Acquisition  
and HDR-Compliant HLG (Hybrid Log-Gamma)

WIDE-ANGLE LENS

24.5 mm at the Wide End with a 20x Optical Zoom Lens

Panasonic developed the new CX Series of handheld camcorders, spearheaded by the AG-CX350, to fuse video, on-air broadcasting, and communication for the next generation. The AG-CX350 features 4K/UHD resolution, 10-bit depth, HDR-compatible image quality, and a host of recording formats for the ultimate creativity in a compact, lightweight body with low power consumption. It is also equipped with an RTSP/RTMP/RTMPS function for live streaming and NDI | HX-ready IP connectivity, to serve as a live camera, and clearly expands the usability of the handheld camcorder beyond conventional news gathering and recording applications to meet a wide range of professional needs.

GENERATION CREATIVITY AND CONNECTIVITY

# CONNECTIVITY

## LIVE STREAMING

HD Streaming Distribution Possible While Recording.  
RTSP/RTMP/RTMPS Streaming Methods Supported.

## NDI|HX CONNECT

Industry-First NDI|HX Compatibility\* Via Camcorder.  
Transmission/Remote Support by IP Connection.



\* Recording, streaming and 4K output are not available when using NDI|HX mode. Industry's first camcorder to support NDI|HX. As of June 2019 (according to a Panasonic survey). To use this function, an activation keycode from NewTek is required. Keycodes can be purchased from the following website: [http://new.tk/ndi\\_panicsonic](http://new.tk/ndi_panicsonic)

# The Wide-Angle Lens, New 1.0-type Sensor and High-Quality Pictures in 4K/HDR

## Wide-Angle 24.5 mm<sup>\*1</sup> Optical 20x Zoom, Plus i.Zoom



An image shot in a room using the wide angle.

Panasonic boasts the world's largest market share in the aspherical lens segment. Its cutting-edge optical technology was maximized in the development of the integrated lens used in the AG-CX350. This lens has the industry's widest angle of 24.5 mm<sup>\*1</sup> on the wide end and allows recording of wide-angle images with minimal distortion, without the use of a conversion lens. The optical 20x zoom covers up to 490 mm telephoto in all modes. Furthermore, the i.Zoom enables seamless zooming of up to 32x in HD or up to 24x in UHD from the telephoto end with no degradation in resolution. The AG-CX350 also comes with digital 2x/ 5x/ 10x zoom.<sup>\*2</sup>

\*1: In 35 mm equivalent. The AG-CX350's wide 24.5 mm angle is the widest in the industry for UHD/FHD (16:9). In the segment of camcorders with integrated lens, the Panasonic AG-UX180 achieved the industry's widest angle of 24 mm in UHD/24p (17:9). For UHD/FHD (16:9), 25.4 mm is the widest angle in the industry. (Both As of June 2019, according to a Panasonic survey)

\*2: When using the digital zoom, picture quality degrades as the magnification rate increases.



## HDR-Compliant HLG (Hybrid Log-Gamma)



HDR (High Dynamic Range) Image

The AG-CX350 features HLG (Hybrid Log-Gamma)\* to support HDR (High Dynamic Range). This achieves a wide dynamic range on HDR-compatible TV monitors. The gamma mode can be selected from eight modes (HD, SD, FILMLIKE 1, FILMLIKE 2, FILMLIKE 3, FILM-REC, VIDEO-REC, HLG).

\* The HLG specification was developed jointly by Japanese broadcaster NHK and the BBC in the UK. It is defined in ARIB STD-B67 and ITU Rec. 2100.

## New High-Definition, High-Sensitivity 1.0-type 15M MOS Sensor

The 1.0-type MOS (approximately 15,030,000 pixels) offers an outstanding depth of field and excellent balance between image quality and sensitivity. It supports multi-formats, such as UHD (3840 x 2160), FHD, HD and SD, and provides images without cropping in all modes. This MOS sensor also boasts high sensitivity of F12 (60 Hz) /F13 (50 Hz) (in both UHD and FHD in High Sensitivity mode).

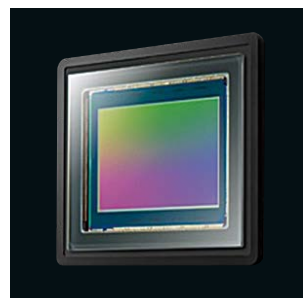

Side Operation

# Control Functions for Light, Smart Camera Work

## Built-in 5-Axis Hybrid Image Stabilizer

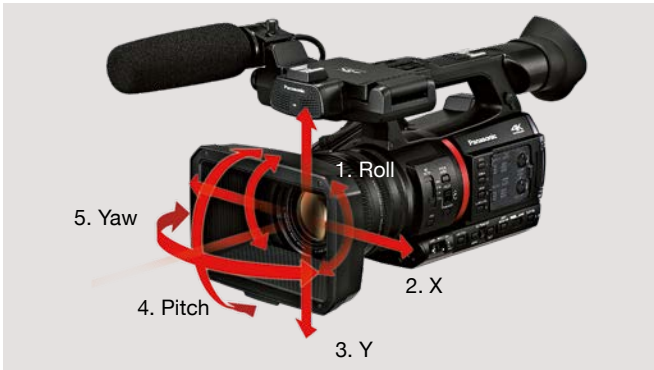

5-Axis Hybrid Image Stabilize

The AG-CX350 has a built-in hybrid image stabilizer that combines optical and electronic camera shake compensation functions. It corrects camera shake in five axial directions in all modes\* including UHD to provide powerful camera shake compensation power in low-angle shooting, high-angle shooting and all other unstable conditions. There are three modes to choose from: NORMAL (standard), STABLE (effective for fixed-frame shooting) and PAN/TILT (effective in panning and tilting).

\* Excluding Super Slow and VFR modes.

## Intelligent AF and Focus Assist

The AG-CX350's auto focus system is Intelligent AF, which is equipped with a micro drive focus unit to achieve high focusing speed, excellent tracking performance and superb stability. The AG-CX350 is also equipped with Expand and Peaking (simultaneous display possible), Manual Focus Assist, LCD Touch Focus (switchable to Auto Iris or brightness display) and One-Push AF Focus Assist.

## Manual Three Rings

The AG-CX350 comes with Manual Three Rings for zoom, focus and iris control. They deliver quick response and provide tactile feel that satisfies professionals. The zoom lever located at the upper section of the handle has a multi-step variable zoom function, allowing smooth zooming from ultra-low speed when shooting from low angle shooting and when a tripod is used.



Manual Three Rings

## Cabled/Wireless Remote Control Capability



Example of Third-party Remote Controller

### • Wired Remote Control with a Third-Party Controller

The remote terminal (2.5 mm super mini jack) enables the control of the focus and zoom using a remote controller (third-party product).

### • Wireless Control from a Tablet or Smartphone

The AG-CX350 can be controlled remotely and wirelessly using a tablet/smartphone app<sup>1</sup> (downloadable for free from the App Store or Google Play). In addition to zoom, i.Zoom and focus lens control, the app enables remote control of various other functions, including camera setting, picture quality adjustment, REC start/stop and menu setting. What's more, the app can be used to select the camera to control from up to eight cameras.<sup>2</sup>



\* Pictures simulated.



<sup>1</sup>: iPad: iOS 9 or later are supported. Android devices: Android 5.0 or later are supported. Wireless module (sold separately; AJ-WM50 or recommended third-party Wi-Fi dongle) is required.

<sup>2</sup>: The app does not support simultaneous/synchronous control of multiple cameras. Camera switching takes several seconds.

# Multi-Codec Recording of High-Quality 10-bit Images without Cropping

## New HEVC Codec for High-Image-Quality 10-bit UHD/60p Recording at Low Bit Rate

The AG-CX350 is capable of recording in various formats at different compression rates (see the table below). It can record UHD/60p videos in high-image-quality 10-bit on an SD memory card. It also features a new, high-efficiency HEVC codec (LongGOP, 10-bit, 4:2:0, MOV). When a PC with 7th Generation Intel Core i7 processor is used, the hardware acceleration enables native decoding and playback. Free software, such as VLC Media Player or QuickTime Player, provides smooth playback on a notebook PC or MacBook with Intel Core i7 processor.\*



\* Playback may lack smoothness depending on the PC environment, such as storage and memory devices.

## MOV/AVCHD/P2 MXF\* File Formats Supported

The AG-CX350 records MOV files that are highly compatible and easy to use. This file format is the same as that used on Panasonic's compact cinema camera, the AU-EVA1, and supports file names with up to 20 characters, allowing recorded video clips to be easily managed. The AG-CX350 also supports conventional AVCHD recording, including the AVCHD 8 Mb/s mode, used widely as the format in college and professional football coaching analysis. And it will support the MXF P2 file format for broadcasting, enabling AVC-Intra or AVC-LongG recording.\*

\* To be supported within 2019. AVC-Intra200/100/50 codec will be supported in the future. Use a microP2 card for recording in P2 format.

## 10-bit Variable Frame Rate (VFR) without Cropping



Simulated Image

In UHD, variable frame rate (VFR) recording at 1 fps to 60 fps is possible. In FHD, super-slow can be realized at a maximum of 120 fps. Both provide high-quality 10-bit, full-frame pictures with no image area cropping even at high frame rates.

## Freeze Frame (Still Image Capture)

When playing back video clips on the AG-CX350, any desired frame can be captured as a still image (JPEG) and recorded onto an SD memory card. Video playback, frame advance (+/-), and still-image captures can all be done intuitively by touch panel operation.

## Recording Format

| Recording Format |                 | Pixels              | Color Sampling                        | Bit Depth | Bit Rate       | File Format                      | VFR*2  | Audio  |             |
|------------------|-----------------|---------------------|---------------------------------------|-----------|----------------|----------------------------------|--|--|-------------|
| MOV (HEVC)       |                 | HEVC LongGOP 200M   | 3840 x 2160                           | 4:2:0     | 10 bit         | 200 Mbps (VBR)                   | 59.94p, 50p  | 24 bit LPCM  |             |
|                  |                 | HEVC LongGOP 150M   | 3840 x 2160                           | 4:2:0     | 10 bit         | 150 Mbps (VBR)                   | 29.97p, 25p, 23.98p  |  |             |
|                  |                 | HEVC LongGOP 100M*1 | 3840 x 2160                           | 4:2:0     | 10 bit         | 100 Mbps (VBR)                   | 59.94p, 50p  |  |             |
| MOV (AVC)        | UHD             | 422ALL-I 400M       | 3840 x 2160                           | 4:2:2     | 10 bit         | 400 Mbps (VBR)                   | 29.97p, 25p, 23.98p  | 1 to 30 fps [25 fps]   | 24 bit LPCM |
|                  |                 | 422LongGOP 150M     | 3840 x 2160                           | 4:2:2     | 10 bit         | 150 Mbps (VBR)                   | 29.97p, 25p, 23.98p  | 1 to 30 fps [25 fps]   |             |
|                  |                 | 420LongGOP 150M     | 3840 x 2160                           | 4:2:0     | 8 bit          | 150 Mbps (VBR)                   | 59.94p, 50p  | 1 to 60 fps [50 fps] (Max. 150 Mbps)                               |             |
|                  | 420LongGOP 100M | 3840 x 2160         | 4:2:0                                 | 8 bit     | 100 Mbps (VBR) | 29.97p, 25p, 23.98p              | 1 to 60 fps [50 fps] (Max. 150 Mbps)                               |  |             |
|                  | FHD             | 422ALL-I 200M       | 1920 x 1080                           | 4:2:2     | 10 bit         | 200 Mbps (VBR)                   | 59.94p, 50p  | 1 to 60 fps [50 fps] Super Slow: 120 fps [100 fps] (Max. 400 Mbps) |             |
|                  |                 | 422ALL-I 100M       | 1920 x 1080                           | 4:2:2     | 10 bit         | 100 Mbps (VBR)                   | 29.97p, 25p, 23.98p, 59.94i, 50i                                   | 1 to 60 fps [50 fps] Super Slow: 120 fps [100 fps] (Max. 200 Mbps) |             |
| 422LongGOP 50M   |                 | 1920 x 1080         | 4:2:2                                 | 10 bit    | 50 Mbps (VBR)  | 29.97p, 25p, 23.98p, 59.94i, 50i | 1 to 60 fps [50 fps] Super Slow: 120 fps [100 fps] (Max. 200 Mbps) |  |             |
| AVCHD            |                 | PS                  | 1920 x 1080                           | 4:2:0     | 8 bit          | 25 Mbps (VBR)                    | 59.94p, 50p  | Dolby Audio  |             |
|                  |                 | PH                  | 1920 x 1080                           | 4:2:0     | 8 bit          | 21 Mbps (VBR)                    | 23.98p, 59.94i, 50i  |  |             |
|                  |                 | HA                  | 1920 x 1080                           | 4:2:0     | 8 bit          | 17 Mbps (VBR)                    | 59.94i, 50i  |  |             |
|                  | HD              | PM                  | 1280 x 720                            | 4:2:0     | 8 bit          | 8 Mbps (VBR)                     | 59.94p, 50p  |  |             |
|                  | SD              | SA                  | 720 x 480 (59.94i)<br>720 x 576 (50i) | 4:2:0     | 8 bit          | 9 Mbps (VBR)                     | 59.94i, 50i  |  |             |
| P2*1 (MXF)       | FHD             | AVC-Intra422*1      | 1920 x 1080                           | 4:2:2     | 10 bit         | 200 Mbps (CBR)                   | 59.94p, 50p  | 24 bit LPCM  |             |
|                  |                 | AVC-LongG50*1       | 1920 x 1080                           | 4:2:2     | 10 bit         | 50 Mbps (VBR)                    | 59.94i, 50i  |  |             |
|                  |                 | AVC-LongG25*1       | 1920 x 1080                           | 4:2:2     | 10 bit         | 25 Mbps (VBR)                    | 59.94p, 50p, 59.94i, 50i   |  |             |
|                  | HD              | AVC-LongG12*1       | 1920 x 1080                           | 4:2:0     | 8 bit          | 12 Mbps (VBR)                    | 59.94p, 50p, 59.94i, 50i   | 16 bit LPCM  |             |
|                  |                 | AVC-LongG50*1       | 1280 x 720                            | 4:2:2     | 10 bit         | 50 Mbps (VBR)                    | 59.94p, 50p  | 24 bit LPCM  |             |
|                  |                 | AVC-LongG25*1       | 1280 x 720                            | 4:2:2     | 10 bit         | 25 Mbps (VBR)                    | 59.94p, 50p  | 24 bit LPCM  |             |
|                  | AVC-LongG12*1   | 1280 x 720          | 4:2:0                                 | 8 bit     | 12 Mbps (VBR)  | 59.94p, 50p                      | 16 bit LPCM  |  |             |

\*1: To be supported within 2019. \*2: VFR is supported only in Progressive mode. Square brackets [ ] indicate a system frequency of 50.00 Hz.

# High-Quality Image and Sound Functions for Maximum Creativity

## Broadcast-Grade Picture Quality Adjustment Functions

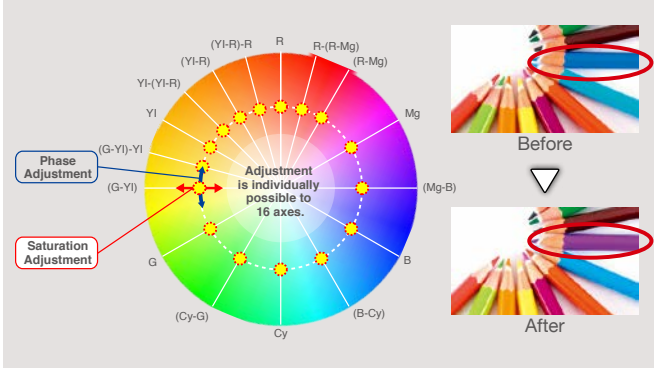

16-Axis Independent Color Correction Illustration

- **16-Axis Independent Color Correction:** Provides an independent effect to each of the 16 phases of video images. It enables color matching of multiple cameras under the same lighting conditions as well as creative image rendering.
- **Master Detail:** Adjusts the overall degree of contour enhancement.
- **Skin Detail:** Makes skin colors appear soft and beautiful.
- **Scene Files:** Six preset files are provided. You can change any of the settings as desired.
- **Other Picture Settings:** Matrix tables, V detail, detail coring, chroma level, chroma phase, color temperature, master pedestal and knee.

## 24-bit PCM Audio 4-Channel Recording

The use of the built-in stereo microphone or XLR input (switchable 48-V phantom power supply/MIC/LINE) allows 2-channel audio recording. In MOV mode, 24-bit linear PCM recording delivers higher sound quality. Future firmware update will enable 4-channel recording.<sup>1</sup> Other audio features include manual volumes, OSD level meter, 1 kHz test tone output<sup>2</sup> and headphone output (3.5 mm-diameter stereo mini jack).

<sup>1</sup>: When MOV or P2 MXF is selected as the main recording format, the AG-CX350 enables 4-channel recording using the built-in microphone (2-channels) and XLR (2-channels). In AVC-LongG12 mode, only 16-bit LPCM 4-channel recording is supported. And in AVCHD mode, only 2-channel recording is possible.

<sup>2</sup>: This output is produced when the color bar is displayed. When the 50 Hz system frequency is selected, the output is 997 Hz.

## Double Memory Card Slots Improve Recording Reliability

Two SD memory card slots capable of using SDXC/SDHC/microP2 cards<sup>1</sup> enable unlimited<sup>2</sup> relay recording by simply changing SD memory cards. Recording reliability is further improved with simultaneous recording and background recording. And the AG-CX350 is equipped with Pre Rec, Interval Rec and Time Stamp recording functions.

<sup>1</sup> For memory card usage conditions, see the "Recording Media" chart on page 11.

<sup>2</sup> If the Relay recording time reaches 10 hours, shooting will temporarily stop, and then automatically restart a few seconds later. If it is recorded in MOV format, the file will be split every 3 hours and recorded.

### Unlimited\* Relay Recording

Automatically records continuously from Slot 1 to Slot 2. By changing a full card with a new card, images can be recorded continuously for many hours.

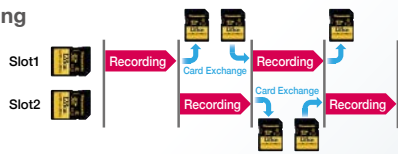

### Simultaneous Recording

Identical data is recorded onto cards in both slots in this dual recording mode.

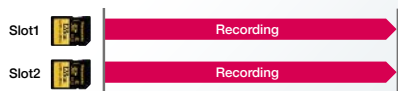

### Background Recording

Records ordinary Rec Start/Stop-controlled data in Slot 1, and records all data, even when Slot 1 is stopped, in Slot 2.



## Simultaneous Display on High-Brightness, High-Definition LCD and High-Resolution OLED EVF



LCD Monitor Screen While Shooting (Pictures simulated)

The AG-CX350 features a new 3.2-type high-definition LCD monitor (approximately 1,620,000 dots). This LCD monitor uses the RGBW (red, green, blue, white) pixel structure to provide high visibility even in bright sunlight. The 3:2 aspect ratio enables the display of timecode and camera status without superimposing on the image. The touch panel function allows convenient touch focus and menu setting. The viewfinder is a high-resolution color OLED (approximately 2,360,000 dots, with an image display area of approximately 1,770,000 dots) that offers superb color reproduction. Since the AG-CX350 newly supports simultaneous LCD and EVF outputs, the LCD monitor can display the captured image at all times even when you look away from the EVF.



Rear Terminal

# Advanced System Functions Supporting Live Streaming and IP Connection

## RTSP/RTMP/RTMPS-Compatible HD Streaming

HD streaming is possible while images are being acquired.\*<sup>1</sup> RTSP, RTMP and RTMPS streaming methods are compatible.\*<sup>2</sup> And Facebook, YouTube, and other streaming services are supported. The AG-CX350 can be used for live coverage of concerts and sports events as well as for live streaming of breaking news. Multicast streaming is also supported.\*<sup>3</sup>

\*1: There are some conditions under which streaming is not possible, such as when recording in UHD format or using NDI|HX mode. Please see the Operating Instruction Manual for details.

\*2: The P2 Network Setting Software is convenient for setting up the RTMP and RTMPS functions. See the section, "Connectivity-verified live video services," for the live video streaming services that have been confirmed to be compatible.

\*3: To be supported within 2019.



Operating Instruction Manual



Connectivity-verified Live Video Services

## Easy IP Connection: NDI | HX Capable – NDI | HX is enabled when optional NDI | HX licence is purchased from NewTek

The AG-CX350 is the industry's first camcorder to support NDI | HX.\* Equipped with NDI | HX mode, it allows video transmission and camera control via IP connection, without using an external converter. When connected to a system configured with the AV-HLC100 Live Production Center and HN/UN series PTZ integrated cameras, the AG-CX350 realizes end-to-end live video production of live events as well as web distribution.

\* NDI | HX, a technology of NewTek, Inc.

\* Recording, streaming and 4K output are not available when using NDI | HX mode. Industry's first camcorder to support NDI | HX. As of June 2019 (according to a Panasonic survey). To use this function, an activation keycode from NewTek is required. Keycodes can be purchased from the following website: [http://new.tk/ndi\\_panasonic](http://new.tk/ndi_panasonic)

## TC Synchro Multi-Camera Recording Supported

The TC IN/OUT terminal (BNC) allows synchronization of the time code in multi-camera shooting. The camera number (A to Z) can be added\* to the name of the recording folder to facilitate editing.

\* Only when the MOV codec is used for recording. Setting must be made in each camera.

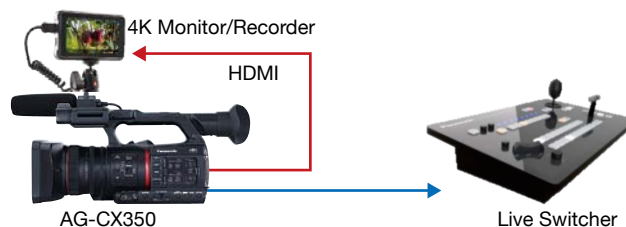

## Parallel Output of SDI and HDMI

SDI and HDMI can be output in parallel. Output of UHD video via HDMI and output of HD video in high-image-quality 10-bit, 4:2:2 via SDI enable a variety of uses. In HLG shooting, either HDR or SDR can be selected for each of the SDI, HDMI and LCD video outputs.

## Low Power Consuming, Large-Capacity Battery, Quick Charge

The AG-CX350 boasts low power consumption of 11.5 W (in factory setting, with no devices connected to the terminals), which is the industry's lowest in the UHD/HD 10-bit recording professional camcorder segment. The maximum power consumption is only 17 W (HEVC recording, LCD turned ON, devices connected to the terminals).<sup>1</sup> With the supplied battery pack (5900 mAh), the AG-CX350 operates continuously for about 3 hours and 20 minutes. This large-capacity battery pack supports quick charges.\*<sup>2</sup> For product details, see page 6.

\*1: As of June 2019. According to a Panasonic survey.

\*2 Quick charge is possible only when the AG-BRD50 battery charger is used.

## Workflow

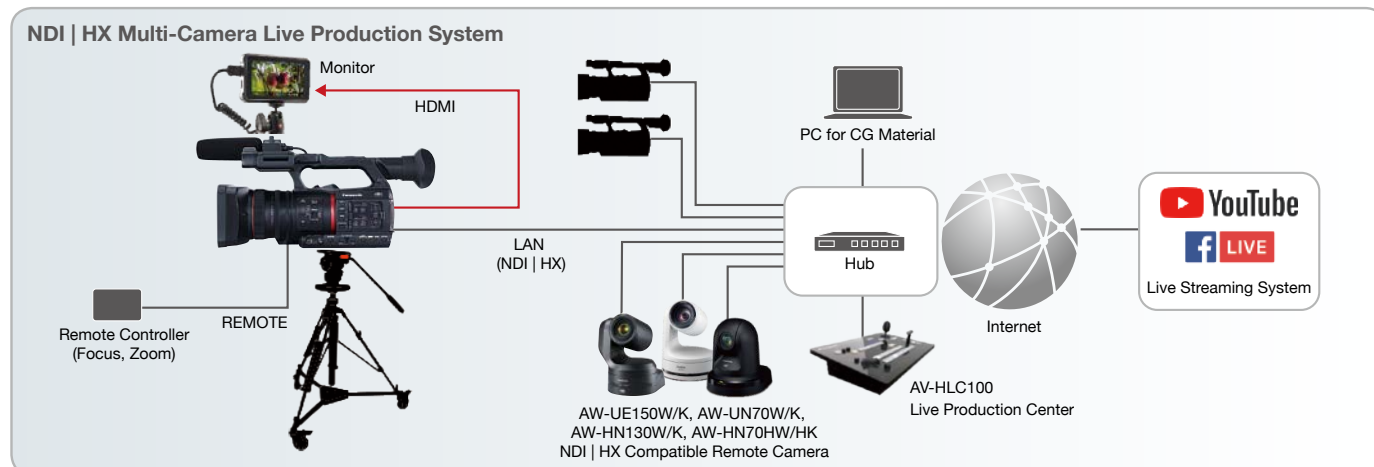
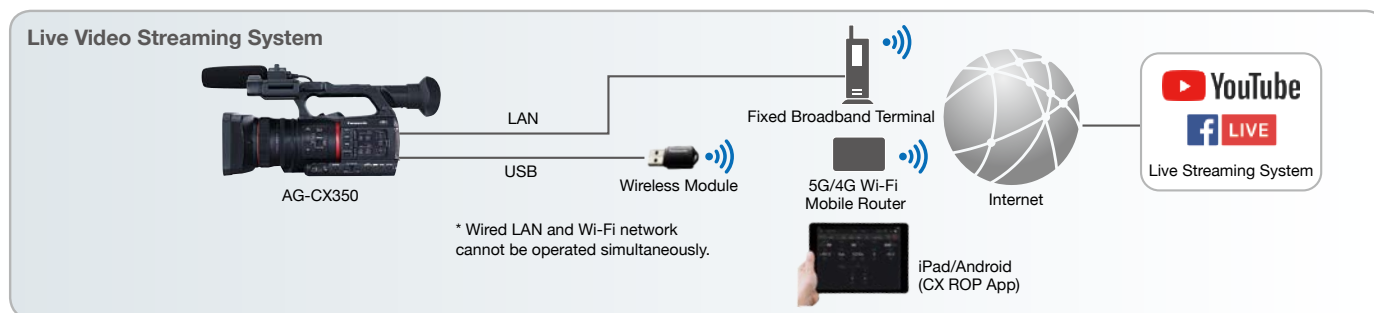





**AG-VBR118G** (11,800 mAh)  
Battery Pack



**AG-VBR89G** (8,850 mAh)  
Battery Pack



**AG-VBR59** (5,900 mAh)  
Battery Pack



**AG-BRD50**  
Battery Charger



**VW-VBD58** (5,800 mAh)  
Battery Pack



**AG-B23**  
Battery Charger

### Available Battery Pack

| Battery           | Voltage/Capacity       | Charge Time             | Continuous Shooting Time |
|-------------------|------------------------|-------------------------|--------------------------|
| AG-VBR59 (bundle) | 7.28 V 5900 mAh 43 Wh  | Approx. 3 hours 20 min. | Approx. 3 hours 20 min.  |
| AG-VBR89G         | 7.28 V 8850 mAh 65 Wh  | Approx. 4 hours         | Approx. 5 hours          |
| AG-VBR118G        | 7.28 V 11800 mAh 86 Wh | Approx. 4 hours 40 min. | Approx. 6 hours 40 min.  |
| VW-VBD58          | 7.2 V 5800 mAh 42 Wh   | Approx. 5 hours 20 min. | Approx. 3 hours 10 min.  |

\*When using bundled battery charger.



**AG-MC200G**  
XLR Microphone



**AJ-WM50**  
Wireless Module  
\*Not available in some areas



Connection confirmed wireless module (including third-party products)  
[https://pro-av.panasonic.net/en/sales\\_o/p2/server/wireless\\_module.html](https://pro-av.panasonic.net/en/sales_o/p2/server/wireless_module.html)



**AJ-P2M064BG**  
Memory Card "microP2 card B series"

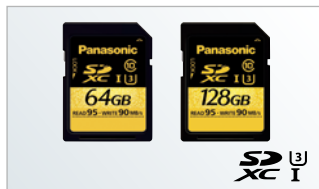

SD/SDHC/SDXC Memory Card \*  
\* UHS Speed Class 3 (U3) SD memory card is necessary for video recording of 100 Mbps or more. UHS Speed Class 3 (U3) SDXC memory card of 64 GB or more is necessary for video recording of UHD2160/59.94p/50.00p 150 Mbps.

# Specifications

## General

|                        |   |
|------------------------|---|
| Power:                 | DC 7.28 V (when the battery is used)<br>DC 12 V (when the AC adaptor is used)   |
| Power Consumption:     | 17 W (when the LCD monitor is used)<br>11.5 W (1080i / 422ALL-I 100M recording, when the LCD monitor is used, no external device connection)  |
| Operating Temperature: | 0 °C to 40 °C (32 °F to 104 °F)   |
| Operating Humidity:    | 10 % to 80 % (no condensation)  |
| Weight:                | Body: approx. 1.9 kg (4.19 lb)<br>(body only, excluding lens hood, battery, and accessories)<br>Shooting: approx. 2.3 kg (5.07 lb)<br>(including lens hood, battery, and microphone holder) |
| Dimensions:            | 180 mm (W) x 173 mm (H) x 311 mm (D)<br>(7-1/8 inches x 6-13/16 inches x 12-1/4 inches)<br>(excluding protrusion and eye cup)   |

## Camera Unit

|                                  |  |
|----------------------------------|--|
| Pickup Device:                   | 1.0-type (effective size) MOS solid state image sensor   |
| Effective Pixels:                | 15,030,000 pixel   |
| Lens:                            | Optical image stabilizer lens, optical 20x motorized zoom<br>F value: F2.8 to F4.5<br>Focal length: f=8.8 mm to 176 mm<br>35 mm equivalent: 24.5 mm to 490 mm<br>Filter Diameter: 67 mm<br>ND Filter: Clear, 1/4, 1/16, 1/64<br>IR Filter: Incorporates the ON/OFF control function<br>Shortest Shooting Distance (M.O.D.):<br>Approx. 10 cm (W), 1.0 m (T) from the front lens  |
| Gain Setting:                    | L/M/H selector switch<br>-3 dB to 18 dB (Adjustable in 1 dB steps)<br>24 dB, 30 dB, 36 dB switched<br>(when assigning [S. GAIN] to the USER button)  |
| Color Temperature Setting:       | ATW, ATW LOCK, A ch, B ch,<br>preset 3200 K/preset 5600 K/VAR (2000 K to 15000 K)  |
| Shutter Speed:                   | When [SYSTEM MODE] = 59.94 Hz<br>• 59.94i/59.94p mode:<br>1/60 sec. (shutter off), 1/100 sec., 1/120 sec., 1/250 sec.,<br>1/500 sec., 1/1000 sec., 1/2000 sec., 1/4000 sec.,<br>1/8000 sec., 1/10000 sec.<br>• 29.97p mode:<br>1/30 sec., 1/50 sec. (shutter off), 1/60 sec., 1/100 sec.,<br>1/120 sec., 1/250 sec., 1/500 sec., 1/1000 sec., 1/2000 sec.,<br>1/4000 sec., 1/8000 sec., 1/10000 sec.<br>• 23.98p mode:<br>1/24 sec., 1/48 sec., 1/50 sec. (shutter off), 1/60 sec.,<br>1/100 sec., 1/120 sec., 1/250 sec., 1/500 sec., 1/1000 sec.,<br>1/2000 sec., 1/4000 sec., 1/8000 sec., 1/10000 sec.<br>When [SYSTEM MODE] = 50.00 Hz<br>• 50i/50p mode:<br>1/50 sec. (shutter off), 1/60 sec., 1/100 sec., 1/120 sec.,<br>1/250 sec., 1/500 sec., 1/1000 sec., 1/2000 sec.,<br>1/4000 sec., 1/8000 sec., 1/10000 sec.<br>• 25p mode:<br>1/25 sec., 1/50 sec. (shutter off), 1/60 sec., 1/100 sec.,<br>1/120 sec., 1/250 sec., 1/500 sec., 1/1000 sec., 1/2000 sec.,<br>1/4000 sec., 1/8000 sec., 1/10000 sec. |
| Shutter Speed:<br>(Slow Shutter) | When [SYSTEM MODE] = 59.94 Hz<br>• 59.94i/59.94p mode: 1/1 sec., 1/2 sec., 1/4 sec., 1/6 sec.,<br>1/15 sec., 1/30 sec.<br>• 29.97p mode: 1/1 sec., 1/2 sec., 1/4 sec., 1/6 sec., 1/15 sec.<br>• 23.98p mode: 1/1 sec., 1/2 sec., 1/4 sec., 1/6 sec., 1/12 sec.<br>When [SYSTEM MODE] = 50.00 Hz<br>• 50i/50p mode: 1/1 sec., 1/2 sec., 1/4 sec., 1/6 sec.,<br>1/12 sec., 1/25 sec.<br>• 25p mode: 1/1 sec., 1/2 sec., 1/4 sec., 1/6 sec., 1/12 sec.  |
| Shutter Speed:<br>(Synchro Scan) | When [SYSTEM MODE] = 59.94 Hz<br>• 59.94i/59.94p mode: 1/60.0 sec. to 1/7200 sec.<br>• 29.97p mode: 1/30.0 sec. to 1/7200 sec.<br>• 23.98p mode: 1/24.0 sec. to 1/7200 sec.<br>When [SYSTEM MODE] = 50.00 Hz<br>• 50i/50p mode: 1/50.0 sec. to 1/7200 sec.<br>• 25p mode: 1/25.0 sec. to 1/7200 sec.   |
| Shutter Open Angle:              | 3.0 deg to 180.0 deg to 360.0 deg (in 0.5 deg steps)   |

|                           |  |
|---------------------------|--|
| VFR Recording Frame Rate: | When [SYSTEM MODE] = 59.94 Hz<br>1, 2, 4, 6, 9, 12, 15, 18, 20, 21, 22, 24, 25, 26, 27, 28, 30, 32,<br>34, 36, 40, 44, 48, 54, 60 (fps)<br>When [SYSTEM MODE] = 50.00 Hz<br>1, 2, 4, 6, 9, 12, 15, 18, 20, 21, 22, 23, 24, 25, 26, 27, 28, 30,<br>32, 34, 37, 42, 45, 48, 50 (fps) |
| Super Slow Recording:     | When [SYSTEM MODE] = 59.94 Hz<br>1920 x 1080 (FHD): shooting frame rate 120 fps<br>When [SYSTEM MODE] = 50.00 Hz<br>1920 x 1080 (FHD): shooting frame rate 100 fps   |
| Sensitivity:              | When [HIGH SENS.] mode<br>F12 (2000 lx, 3200 K, 89.9 % reflect, 2160/59.94p, 1080/59.94i)<br>F13 (2000 lx, 3200 K, 89.9 % reflect, 2160/50p, 1080/50i)   |
| Horizontal Resolution:    | 2000 TV or higher (UHD: center)<br>1000 TV or higher (FHD: center)   |
| i.Zoom:                   | x 32 (FHD), x 24 (UHD)   |
| Digital Zoom:             | x 2 / x 5 / x 10   |
| Lens Hood:                | Hood with lens cover   |

## Memory Card Recorder

|                              |   |
|------------------------------|---|
| Recording Media:             | SDHC memory card (4 GB to 32 GB),<br>SDXC memory card (32 GB to 128 GB)<br>UHS-I/UHS-II UHS Speed Class 3 supported,<br>Video Speed Class V90 supported<br>microP2 card (A series, B series)<br>Please see page 11 for the "Available Memory Card" table. |
| Recording Slot:              | microP2/SDXC UHS-II card slot x 2   |
| Recording Pixels:            | 3840 x 2160 (UHD), 1920 x 1080 (FHD), 1280 x 720 (HD),<br>720 x 480(SD), 720 x 576 (SD)   |
| System Frequency:            | 59.94 Hz/50.00 Hz   |
| Recording File Format:       | MOV (AVC), MOV (HEVC), AVCHD, P2 MXF*   |
| Recording Format:            | Please see page 6 for the "Recording Format" table.   |
| Recording Time:              | Please see page 11 for the "Recording Time" table.  |
| 2 Slot Functions:            | Relay Rec, Simultaneous Rec, Background Rec   |
| Special Recording Functions: | Pre Rec, Interval Rec, Time Stamp   |

## Digital Video

|                           |   |
|---------------------------|---|
| Quantization:             | MOV: 4:2:2 10 bit/4:2:0 8 bit/4:2:0 10 bit (HEVC)<br>AVCHD: 4:2:0 8 bit<br>P2*: 4:2:2 10 bit/4:2:0 8 bit (AVC-LongG12)  |
| Video Compression Format: | MOV: H.264/MPEG-4 AVC High Profile<br>H.265/MPEG-H HEVC Main10 Profile<br>AVC-Intra422/AVC-LongG50/AVC-LongG25/<br>AVC-LongG12: MPEG-4 AVC/H.264 High Profile<br>P2*: |

## Digital Audio

|                         |   |
|-------------------------|---|
| Recording Audio Signal: | MOV: 48 kHz/24 bit, 2 ch, Linear PCM<br>AVCHD: 48 kHz/16 bit, 2 ch, Dolby Audio™<br>P2*: 48 kHz/24 bit, 4 ch, Linear PCM<br>(In AVC-LongG12, 48 kHz/16 bit, 4 ch) |
| Headroom:               | 12 dB/18 dB/20 dB switchable (menu)   |

## Live Streaming

|                           |  |
|---------------------------|--|
| Video Compression Format: | H.264/MPEG-4 AVC Main Profile, High Profile  |
| Video Resolution:         | 1920 x 1080 (FHD), 1280 x 720 (HD),<br>640 x 360, 360 x 180  |
| Streaming Method:         | Unicast, Multicast*  |
| Frame Rate:               | System frequency = 59.94 Hz: 30 fps, 60 fps<br>System frequency = 50.00 Hz: 25 fps, 50 fps                             |
| Bit Rate:                 | 24 Mbps, 20 Mbps, 16 Mbps, 14 Mbps, 8 Mbps,<br>6 Mbps, 4 Mbps, 3 Mbps, 2 Mbps, 1.5 Mbps,<br>1 Mbps, 0.7 Mbps, 0.5 Mbps |
| Audio Compression Format: | AAC-LC, 48 kHz/16 bit, 2 ch  |
| Network Protocol:         | RTSP/RTP/RTMP/RTMPS  |

\*To be supported within 2019.

## Video Output

|            |  |
|------------|--|
| SDI OUT:   | BNC x 1, SDI REC REMOTE supported<br>HD: 0.8 V [p-p], 75 Ω SD: 0.8 V [p-p], 75 Ω,<br>Output format (4:2:2 10 bit):<br>• 1920 x 1080: 59.94p, 50p, 59.94i, 50i,<br>29.97Psf, 25Psf, 23.98PsF<br>• 1280 x 720: 59.94p, 50p<br>• 720 x 480: 59.94i<br>• 720 x 576: 50i                                  |
| HDMI OUT : | HDMI x 1, Type A, HDMI REC REMOTE supported,<br>VIERA Link not supported<br>Output format (4:2:2 10 bit):<br>• 3840 x 2160: 59.94p, 50p, 29.97p, 25p, 23.98p<br>• 1920 x 1080: 59.94p, 50p, 59.94i, 50i, 29.97p, 25p, 23.98p<br>• 1280 x 720: 59.94p, 50p<br>• 720 x 480: 59.94p<br>• 720 x 576: 50p |
| VIDEO OUT: | 3.5 mm diameter mini jack, composite 1.0 V [p-p], 75 Ω   |

## Audio Input/Output

|                      |  |
|----------------------|--|
| Built-in Microphone: | Stereo microphone  |
| Input 1/2:           | XLR (3-pin) x 2 (INPUT1, INPUT2)<br>Input high impedance, LINE/MIC/MIC+48V (switchable SW)<br>MIC: -40 dBu/-50 dBu/-60 dBu (switchable menu)<br>LINE: +4 dBu/0 dBu (switchable menu) |
| SDI OUT:             | Linear PCM 4 ch  |
| HDMI OUT:            | Linear PCM 2 ch  |
| Headphone:           | 3.5 mm diameter stereo mini jack x 1   |
| AV OUT:              | 3.5 mm diameter stereo mini jack x 1,<br>Output level: 600 Ω, 316 mV   |
| Speaker:             | 20 mm diameter, round x 1  |

## Other Input/Output

|                 |   |
|-----------------|---|
| TC IN/OUT:      | BNC x 1,<br>Used as the input and output terminals (switchable menu)<br>Input: 1.0 V to 4.0 V [p-p] 10 kΩ<br>Output: 2.0 V ± 0.5 V [p-p] low impedance  |
| REMOTE:         | 2.5 mm diameter super mini jack   |
| LAN:            | RJ-45: 1000BASE-T/100BASE-TX/10BASE-T<br>NDI   HX supported*<br>*To use this function, an activation keycode from NewTek is required. Keycodes can be purchased from the following website: <a href="http://new.tk/ndi_panasonic">http://new.tk/ndi_panasonic</a> |
| USB 2.0 HOST:   | Type-A, 4-pin (5 V, 0.5 A) for Wireless Module (option)   |
| USB 3.0 DEVICE: | USB 3.1 GEN1 Type-C, USB Mass storage function<br>No USB bus power function   |
| DC IN 12V:      | DC 12 V EIAJ Type 4   |

## Monitor/Viewfinder

|              |  |
|--------------|--|
| LCD Monitor: | 3.5 type TFT LCD color monitor (3:2),<br>approx. 1,620,000 dots, Touch panel<br>video display (16: 9) area: Approx. 1,370,000 dots |
| Viewfinder:  | 0.39 type OLED (organic EL display), approx. 2,360,000 dots,<br>video display (16: 9) area: approx. 1,770,000 dots                 |

## Included Accessories

Battery (AG-VBR59), Battery charger (AG-BRD50), AC adaptor, AC cable, Microphone holder kit, Shoulder strap, Eye cup, Lens hood\*, Grip belt\* and Operating instructions (Items marked by an asterisk (\*) come already attached to the camera)

## Available Memory Card

| Format | Memory Card Type   | Bit Rate / Recording Function                          | Speed Class  |  |                         |
|--------|--|--|--|--|-------------------------|
| MOV    | SDXC memory card/<br>microP2 card B series<br><br>microP2 card A series<br>(64 GB) | 400 Mbps<br>FHD ALL-I VFR mode                         | Video Speed Class V60 or faster  |  |                         |
|        |  | 200 Mbps<br>150 Mbps<br>100 Mbps<br>FHD LongG VFR mode | Video Speed Class V30<br>UHS Speed Class 3 or faster                   |  |                         |
|        |  | 50 Mbps  | Video Speed Class V10<br>UHS Speed Class 1<br>Speed Class 10 or faster |  |                         |
|        |  | AVCHD  | SDHC/SDXC memory card/microP2 card                                     | All  | Speed Class 4 or faster |
|        |  | P2*  | microP2 card   | All P2 recording modes<br>supported by the AG-CX350* | —                       |

\*To be supported within 2019. Use a microP2 card for recording in P2 format.

## Recording Time

| Recording Format   |              | 64 GB Memory Card | 128 GB Memory Card       |                          |
|--------------------|--------------|-------------------|--------------------------|--------------------------|
| MOV<br>(AVC, HEVC) | UHD          | 400 Mbps          | Approx. 20 min.          | Approx. 40 min.          |
|                    |              | 200 Mbps          | Approx. 40 min.          | Approx. 1 hour 20 min.   |
|                    |              | 150 Mbps          | Approx. 55 min.          | Approx. 1 hour 50 min.   |
|                    |              | 100 Mbps          | Approx. 1 hour 20 min.   | Approx. 2 hours 40 min.  |
|                    | FHD          | 100 Mbps          | Approx. 1 hour 20 min.   | Approx. 2 hours 40 min.  |
|                    |              | 50 Mbps           | Approx. 2 hours 40 min.  | Approx. 5 hours 20 min.  |
| AVCHD              | PS           | 25 Mbps           | Approx. 5 hours 20 min.  | Approx. 11 hours         |
|                    | PH           | 21 Mbps           | Approx. 6 hours          | Approx. 12 hours 30 min. |
|                    | HA           | 17 Mbps           | Approx. 8 hours 30 min.  | Approx. 17 hours         |
|                    | PM           | 8 Mbps            | Approx. 17 hours 10 min. | Approx. 35 hours         |
|                    | SA           | 9 Mbps            | Approx. 16 hours 30 min. | Approx. 34 hours         |
| P2*                | AVC-Intra422 | 200 Mbps          | Approx. 32 min.          | Approx. 1 hour 4 min.    |
|                    | AVC-LongG50  | 50 Mbps           | Approx. 2 hours 8 min.   | Approx. 4 hours 16 min.  |
|                    | AVC-LongG25  | 25 Mbps           | Approx. 4 hours 16 min.  | Approx. 8 hours 32 min.  |
|                    | AVC-LongG12  | 12 Mbps           | Approx. 8 hours          | Approx. 16 hours         |

\*To be supported within 2019.

\*AVCHD and the AVCHD logo are registered trademarks of Sony Corporation and Panasonic Corporation. Dolby, Dolby Audio and the double-D symbol are trademarks of Dolby Laboratories. The terms HDMI and HDMI High-Definition Multimedia Interface, and the HDMI Logo are trademarks or registered trademarks of HDMI Licensing Administrator, Inc. in the United States and other countries. SD Logo is a trademark. SDXC/SDHC and SDHC logo marks are the registered trademarks. App Store is a service mark of Apple Inc. Android and Google Play are trademarks or registered trademarks of Google LLC. YouTube™ and YouTube logo are registered trademarks of Google Inc. Facebook is a registered trademark of Facebook, Inc.

\*Specifications are subject to change without notice.

# Panasonic®

Panasonic Corporation  
Connected Solutions Company

2-15 Matsuba-cho, Kadoma, Osaka 571-8503 Japan



For more information, please visit Panasonic web site  
<https://pro-av.panasonic.net/en/qr/>



Factories of AVC Networks Company have received ISO14001:2004-the Environmental Management System certification. (Except for 3rd party's peripherals.)



**Broadcast and Professional AV Website**



**Contact Information**



**Facebook**



**Mobile App**